

Инструменты



Карандаш



Сверло



Силикон

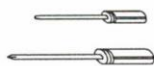

Отвертка



Рулетка



уровень



Дрель

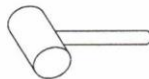

МОЛОТОК

Комплектующие

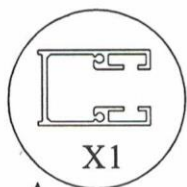

A

X1



B

X2

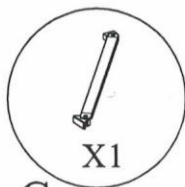

C

X1

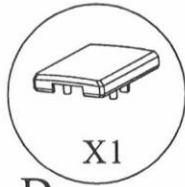

D

X1



E

L/R

X2

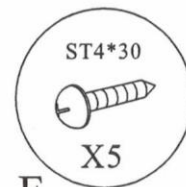

F

ST4*30

X5



G

X5

Схема сборки

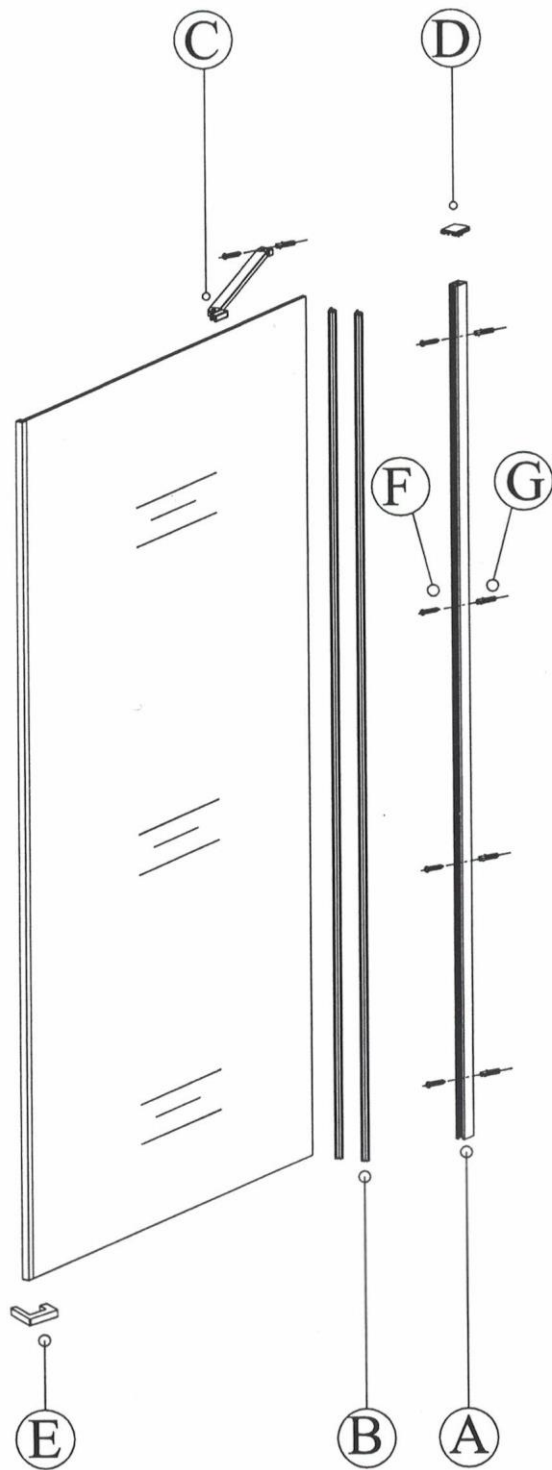

(2)

Инструменты



Карандаш



Сверло



Силикон

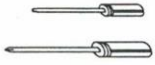

Отвертка



Рулетка



уровень



Дрель

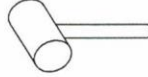

МОЛОТОК

Комплектующие

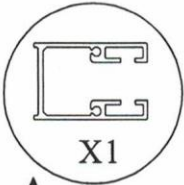

A

X1

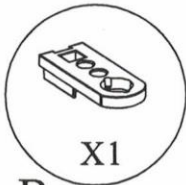

B

X1

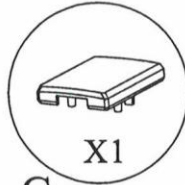

C

X1

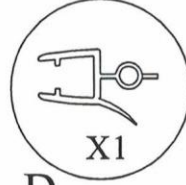

D

X1



E

X1

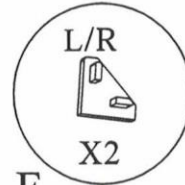

F

L/R
X2



G

X9

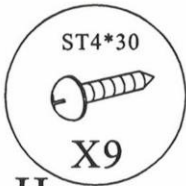

H

ST4*30
X9

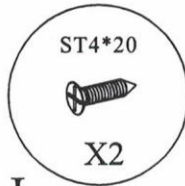

I

ST4*20
X2



J

X2

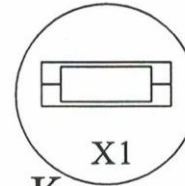

K

X1

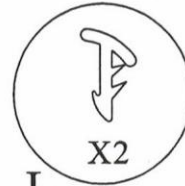

L

X2

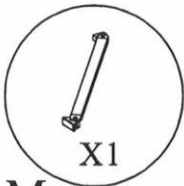

M

X1

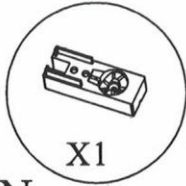

N

X1

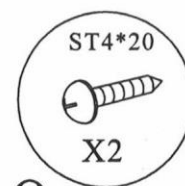

O

ST4*20
X2

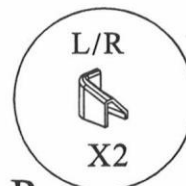

P

L/R
X2

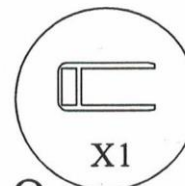

Q

X1

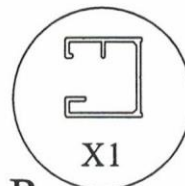

R

X1

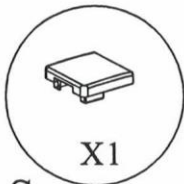

S

X1



T

ST4*12
X4

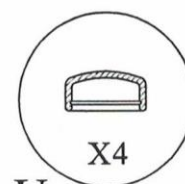

U

X4

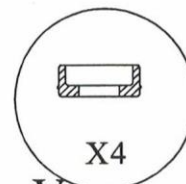

V

X4

Схема сборки

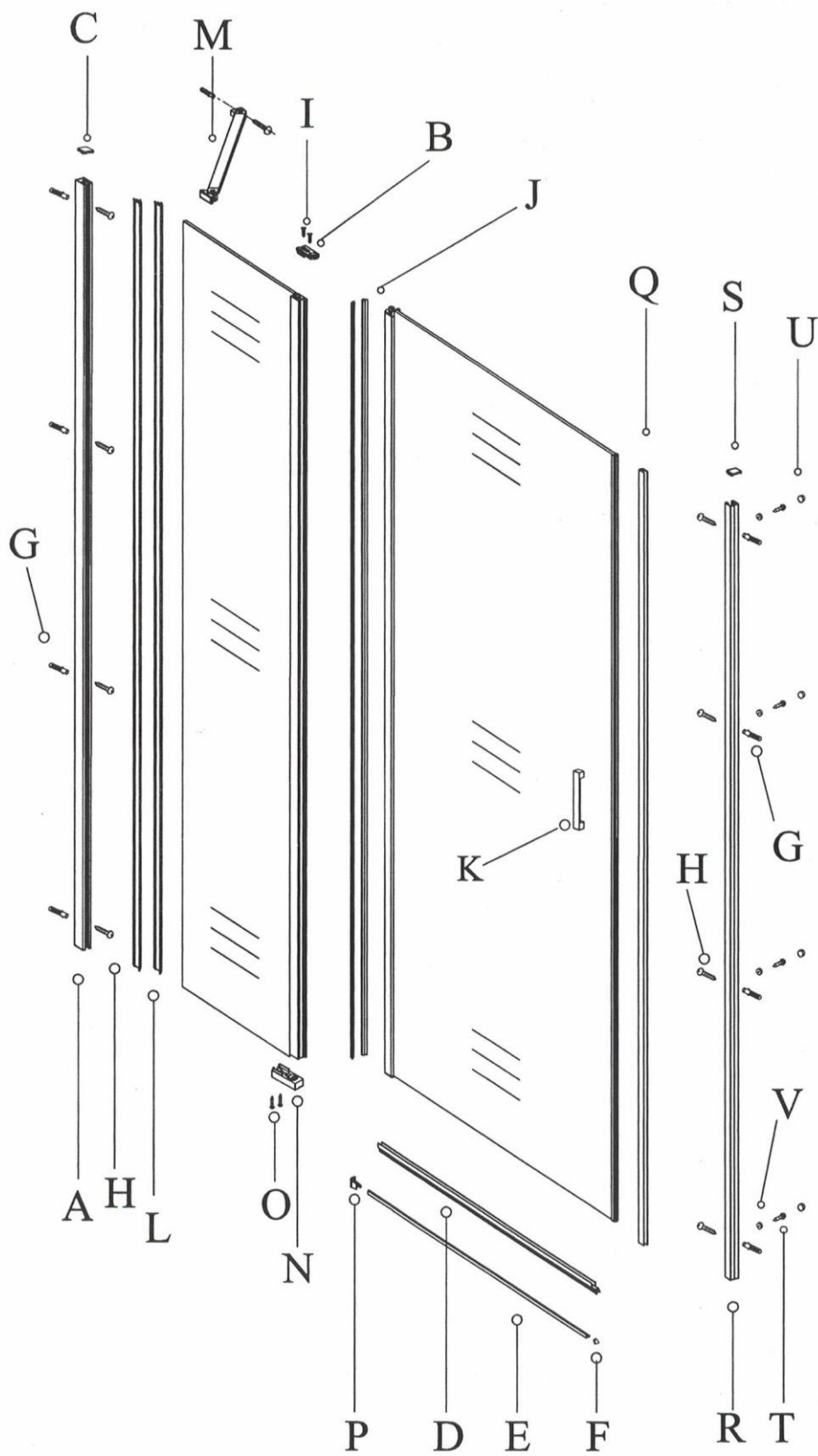

(2)